

YUKON

This high-gloss white acrylic bath offers both the bath lover and the shower lover sufficient comfort and space. The spacious 90 cm wide rounded back has a fine lying shape and in the side walls have cleverly designed armrests included. The curve in the bottom on which you can stand is slightly raised, so that the water can drain quickly when showering. The asymmetrical form comes in two variants; a left and right variant.



Riho acrylic baths are made of high-quality cast acrylic, fully reinforced and all through white in colour. Our acrylic baths are non-aging and UV resistant. The material is completely pore-free and smooth. Lime will adhere poorly so no bacteria remain, also it makes the baths easy to clean. Its surface is pleasantly warm. Standard the bath doesn't include a legset and overflow/drain.

Article nr.	L x W x H (cm)	Volume** (ltr)	Weight (kg)	Water height (cm)	Option Rihopool***
B008001005 (R)	160 x 90 x 48	175	24	39,5	Air / Flow / Joy / Bliss
B009001005 (L)					
B008012005 (R) p&p*	160 x 90 x 62	175	41	39,5	x
B009012005 (L) p&p*					

* Plug&Play are versions with acryl bonded panels for corner placing. These baths include a legset.

** The contents of the baths are measured including the (average) volume of one person.

***Rihopool whirlpool systems already include a legset.

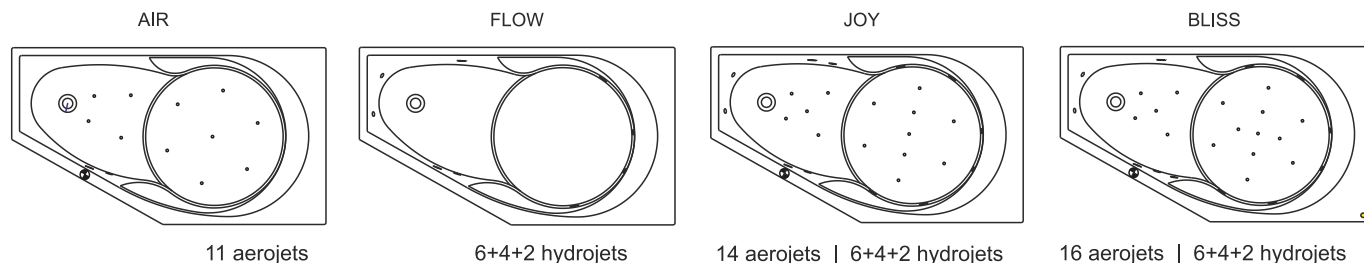

Additional to purchase

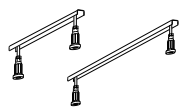

Legset 09
207097

Whirlpools already include a legset!



Mc Alpine
208867



Riho black
208711



Viega Multiplex
208873

Optional to purchase



Headrest 19
207043



Headrest 19
207044



Headrest 05
207024



Headrest 23
207051



Headrest 23
207050



Headrest 26
207052

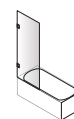

See next page

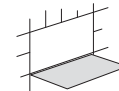

Inspection hatch
207019



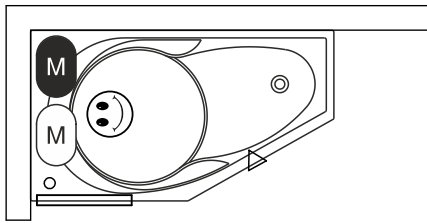

Data is subject to changes and/or errors

Right type

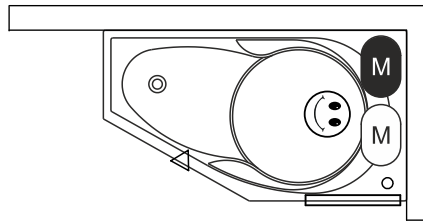

Left type



-  Motor in Air or Flow (Hydro or Aero)
Hydro motor in Joy and Bliss (Hydro + Aero)
-  Aero Motor in Joy and Bliss (Hydro + Aero)
-  Control panel
-  Cleanpool inlet
-  Service hatch

BATHSCREEN	<i>Scandic X500</i>	<i>Novik Z500</i>
-------------------	---------------------	-------------------

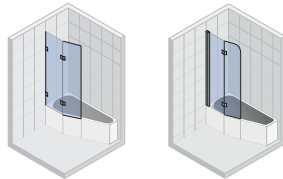

BATH	Acrylic panel	Height (cm)
B008001005 (R)	209283	57
B009001005 (L)	209283	57

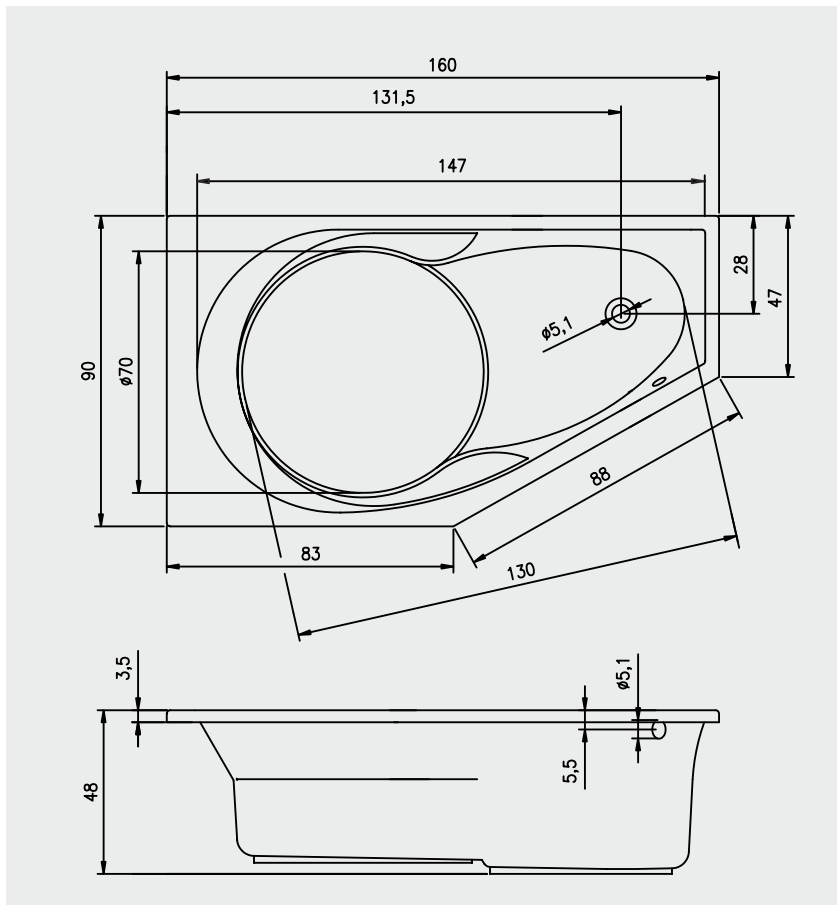

PLUG & PLAY

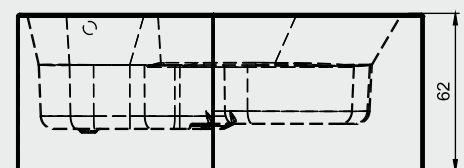
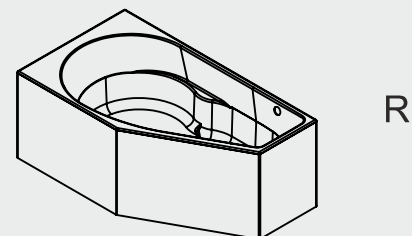
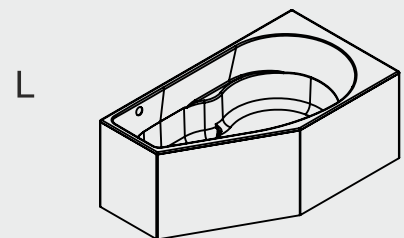

Data is subject to changes and/or errors